

1) Dear exhibitors. If You need any changes to increase/ decrease required space, merge booths to know free and reserved places please communicate with organizers of the fair! You are always welcome!

Current booths quantity :

№	sQm	Booths quantity
1	6	7
2	8	40
3	10	21
4	12	4
5	16	6
6	21	3

2) Below standard booth scheme with standard booth equipment.

Shell-scheme Stands packages

4 sq.m.

- Perimeter wall units
- Carpeting
- Frieze panel with an inscription (15 characters)
- Chairs - 1 pcs.
- Spot - lamp - 1pc
- Waste bin
- Coat-rack wall type

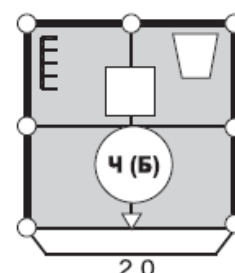
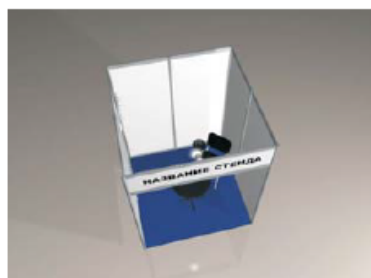

6-8 sq.m.

- Perimeter wall units
- Carpeting
- Frieze panel with an inscription (15 characters)
- Chairs - 2 pcs.
- Spot - lamp - 2 pcs
- Waste bin
- Coat-rack wall type

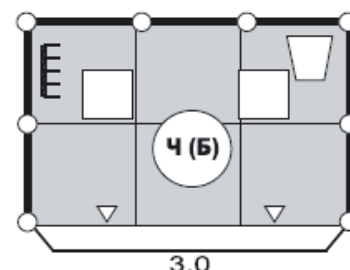
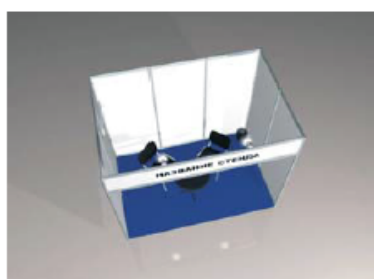

9-11 sq.m.

- Perimeter wall units
- Carpeting
- Frieze panel with an inscription (15 characters)
- Chairs - 3 pcs.
- Podium 1x0,5m h=0,75m - 1pc
- Spot - lamp - 3 pcs
- Waste bin
- Coat-rack wall type

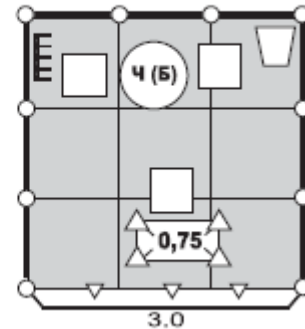
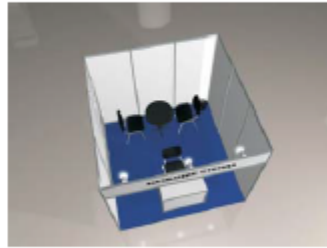

12-14 sq.m.

- Perimeter wall units
- Carpeting
- Frieze panel with an inscription (15 characters)
- Chairs - 3 pcs
- Podium 1x0,5m h=0,75m - 1pc
- Spot - lamp - 4 pcs
- Wall unit - 1 pc
- Curtain - 1 pc
- Waste bin
- Coat-rack wall type
- Electric socket 220 V - 1pc

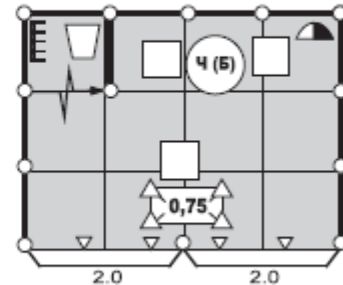
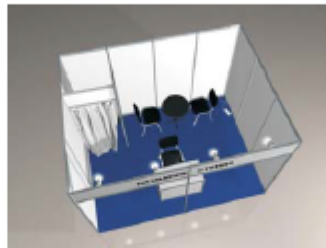





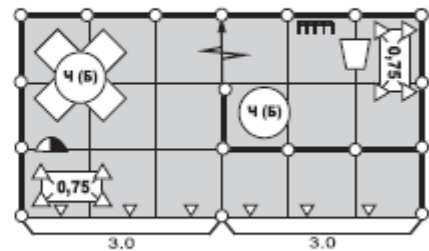
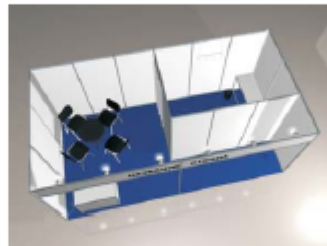













18-20 sq.m.

- Perimeter wall units
- Carpeting
- Frieze panel with an inscription (15 characters)
- Chairs - 4 pcs
- Podium 1x0,5m h=0,75m - 2 pcs
- Spot - lamp - 6 pcs
- Wall unit - 4 pcs
- Folding door - 1 pc
- Waste bin
- Coat-rack wall type
- Electric socket 220 V - 1pc







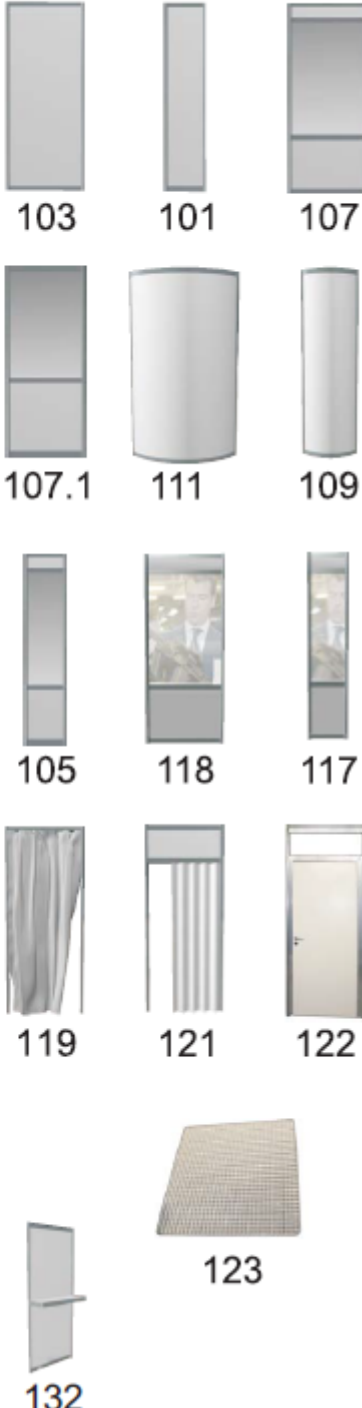



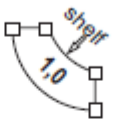

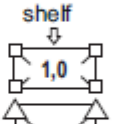



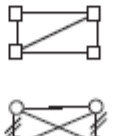

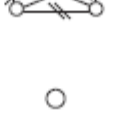

3) If can chose additional equipment (additional cost)



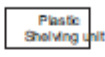

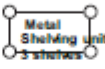
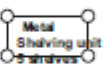







Additional equipment
Booth construction elements













Description	Item number	Photo
Wall panel 2,5x1 m, pcs.	Art. 103	
Wall panel 2,5x0,5 m, pcs.	Art. 101	
Wall panel 2,5x1,5 m, pcs.	Art. 106	
Wall unit with glass 2,5x1m, pcs.	Art. 107	
Wall unit with glass 2,5x0,5m, pcs.	Art. 105	
Wall unit curved R=1m, pcs.	Art. 111	
Wall unit curved R=0,5m, pcs.	Art. 109	
Wall unit with mirror 2,5x1m, pcs.	Art. 118	
Wall unit with mirror 2,5x0,5m, pcs.	Art. 117	
Wall unit with blinds, pcs.	Art. 119	
Folding door, pcs.	Art. 121	
Door unit, pcs.	Art. 122	
Ceiling grid 1x1 m, pcs.	Art. 123	
Shelf (laminated particle board) 1000x300 mm, pcs.	Art. 132	
Glass shelf 470x970 mm, pcs.	Art. 130	
Vertical beam, r.m.	Art. 134	
Connectional purlin, r.m.	Art. 132	
Sliding doors for podium, pair	Art. 135	
		 <p>103 101 107</p> <p>107.1 111 109</p> <p>105 118 117</p> <p>119 121 122</p> <p>123</p> <p>132</p>

Assembly units (showcases, reception desks, table-podiums)







Description	Item number	Photo
Reception desk R-1,0, h=1m, 1pcs	Art. 202	  
Reception desk with the inner shelf, h=1m, 1pcs	Art. 203	  
Podium 1x1m h=0,75m, 1pcs	Art. 206	
Podium 1x0,5m h=0,75m, 1pcs	Art. 209	  
Showcase 1x0,5 m; h=1m, 1pcs	Art. 212	
Showcase high type(2 glass shelves) with sliding doors 1x0,5;h=2,5m, 1pcs	Art. 216	  
Lighting for high showcase (1 lamp 100 W), 1pcs	Art. 217	
Round showcase R-1000 with lighting, 1pcs	Art. 218	
Plastic shelving unit (5 shelves), 1pcs	Art. 220	  
Metal shelving unit 1x0,5m h-2,5 m (3 shelves), 1pcs	Art. 121	
Metal shelf unit 1x0,5m h2,5 m (4 shelves), pcs.	Art. 122	  

Electrical equipment

Spot lamp 100 W, pcs.	Art. 305	  
Pivoting spot lamp 100 W, pcs.	Art. 306	
Pivoting searchlight 150 W, pcs.	Art. 307	   
Lamp 150 W on the bracket, pcs.	Art. 309	
Searchlight 300 W, pcs.	Art. 308	 
Searchlight metallo-halogen (CDMT) 150 W, pcs.	Art. 310	 

Description	Item number		Photo
Electric board 32A, 63A (without connection to pavilion power networks), pcs.	Art. 301 302		 301 302
Luminescent lamp 40W, pcs.	Art. 314		 314
Fluorescent lamp- 40 (color), pcs.	Art. 315		 315
Outlet unit 220 V, pcs.	Art. 318		 318
Power socket 380V (32A), pcs.	Art. 319		 319
Power socket 380V (63A), pcs.	Art. 320		 320
Single twenty-four hour socket 220V, pcs.	Art. 321		













Pivoting boxes

Pivoting cube box 1x1x1 without lighting, pcs.	Art. 401		 401
Pivoting oval box R- 1000 ("lens") without lighting, pcs.	Art. 402		 402
Pivoting round box R-1000, R-1360 ("drum") without lighting, pcs.	Art. 403 404		 403, 404
Lighting for pivoting box	Art. 405		

Decoration work

Description	Item Number	Photo
Covering surface with ORACAL coloured film, sq.m.	Art. 501	 501, 503
Covering surface with translucent film ,sq.m.	Art. 502	
Covering surface with full color printing, sq.m.	Art. 503	
Covering door unit, pcs.	Art. 504	
Light box, sq.m.	Art. 505	
Inscription on the frieze h=10 cm, 1 letter	Art. 506	
Inscription on the frieze h=20 cm, 1 letter	Art. 507	
Logo-monochromic (up to 1 sq.m.), pcs.	Art. 508	
Logo-full colour (up to 1 sq.m.), pcs.	Art. 509	
Computer processing, pcs.	Art. 510	
Full color printing, sq.m.	Art. 511	















Office equipment and furniture

Coat-rack wall type, pcs.	Art. 601	 	 602	 601	 605
Coat-rack floor type, pcs.	Art. 602		 602		
Decorative tree, pcs.	Art. 603		 603		
Leather settee, pcs.	Art. 604			 604	
Blinds 2,5x1m, pcs.	Art. 605	<div style="border: 1px solid black; padding: 2px; display: inline-block;">BLINDS</div>			
Glass coffee table, pcs.	Art. 606			 606	
Mirror floor type, pcs.	Art. 607			 607	
Kitchen set (sink, stove, boiler, bar-refrigerator)	Art. 608	 			 608
Waste bin, pcs.	Art. 609			 609	
Coffee machine SAECO (take in pledge), pcs.	Art. 610				

Decoration work

Description	Item Number	Photo
Covering surface with ORACAL coloured film, sq.m.	Art. 501	 501, 503
Covering surface with translucent film ,sq.m.	Art. 502	
Covering surface with full color printing, sq.m.	Art. 503	
Covering door unit, pcs.	Art. 504	
Light box, sq.m.	Art. 505	
Inscription on the frieze h=10 cm, 1 letter	Art. 506	
Inscription on the frieze h=20 cm, 1 letter	Art. 507	
Logo-monochromic (up to 1 sq.m.), pcs.	Art. 508	
Logo-full colour (up to 1 sq.m.), pcs.	Art. 509	
Computer processing, pcs.	Art. 510	
Full color printing, sq.m.	Art. 511	

Office equipment and furniture











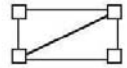
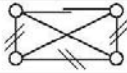

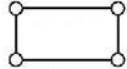
Coat-rack wall type, pcs.	Art. 601	 	 602	 601	 605
Coat-rack floor type, pcs.	Art. 602		 602		
Decorative tree, pcs.	Art. 603		 603		
Leather settee, pcs.	Art. 604			 604	
Blinds 2,5x1m, pcs.	Art. 605	<div style="border: 1px solid black; padding: 2px;">BLINDS</div>			
Glass coffee table, pcs.	Art. 606			 606	
Mirror floor type, pcs.	Art. 607		 	 607	 609
Kitchen set (sink, stove, boiler, bar-refrigerator)	Art. 608				 608
Waste bin, pcs.	Art. 609				
Coffee machine SAECO (take in pledge), pcs.	Art. 610				





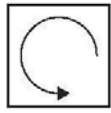

4) Please to fill special form order on the booth construction.

The order for stand construction

Company name	Booth number	Floor space
Inscription on the frieze		
To build standard stand		(Yes/No)
To build stand drawing below:		

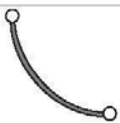
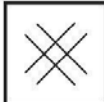
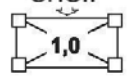
Scale 1 cell = 1 square meter

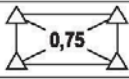
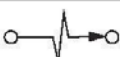
Symbol	Art	Name
	212	Showcase 1x0,5 m; h=1m, 1pcs
	216	Showcase high type (2 glass shelves) with sliding doors 1x0,5,h=2,5m, 1pcs
	217	Lighting for high showcase (1 lamp 100 W) 1pcs
	220	Plastic shelving unit (5 shelves), 1pcs
	121	Metal shelving unit 1x0,5m h=2,5 m (3 shelves), 1pcs
	615	Paper holder pcs.
	637	Filing cabinet 1x0,5 m h=1 m, pcs.
	602	Coat-rack floor type, pcs.
	609	Waste bin, pcs.
	633	Refrigerator 150 L
	305	Spot lamp 100 W, pcs.
	318	Outlet unit 220 V, pcs.
	401	Pivoting cube box 1x1x1 without lighting pcs.
	206	Podium 1x1m h=0,75m, 1pcs
	202	Reception desk R-1,0, h=1m, 1pcs

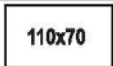
Symbol	Art	Name	Symbol	Art	Name	Symbol	Art	Name
	103	Wall panel 2,5x1 m, pcs.		119	Wall unit with blinds pcs.		625	Round table D=70 cm, pcs.
	111	Wall unit curved R=1m, pcs.		123	Ceiling grid 1x1 m, pcs.		203	Reception desk with the inner shelf h=1m, 1pcs
	107	Wall unit with glass 2,5x1m, pcs.		630	Semi-upholstered chair		209	Podium 1x0,5m h=0,75m, 1pcs
	121	Folding door		629	Chair /bar type/		623	Table 100x70 cm pcs